

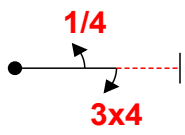

Form A	
Pilot ID	<div style="text-align: center; font-weight: bold; font-size: 1.2em;">CIVA Glider Advanced Known</div>
Flight #	

No	Symbol	Cat. No.	K	Total K	Grade	Pos	Remarks	Item	K	Grade
<b>1</b>		1.1.1.3 9.1.3.1 9.4.3.3	2 3 12	<b>17</b>	.			Pos.	20	
								Harm.	0	
<b>2</b>		1.3.3.2 9.1.2.2	19 9	<b>28</b>	.			Fig K		Total K
								175	195	
<b>3</b>		1.1.3.4 9.1.4.2	7 6	<b>13</b>	.			Penalties		
								Too Low		
<b>4</b>		8.5.9.1 9.1.5.1	12 3	<b>15</b>	.			Too High		
								Interruptions		
<b>5</b>		6.2.2.1 9.1.5.1	17 3	<b>20</b>	.			Insertions		
								Trg Violation		
<b>6</b>		1.1.1.1 9.1.3.4	2 12	<b>14</b>	.			Wing Rocks		
								Disqual Fig		
<b>7</b>		5.2.1.1	17	<b>17</b>	.			Other(note...)		
								Final Freestyle		
<b>8</b>		7.4.1.1 9.1.3.4	10 12	<b>22</b>	.			Duration	Min	Sec
<b>9</b>		1.2.3.1 9.4.2.2	12 11	<b>23</b>	.			Judges Details		
								Signature		
<b>10</b>		2.4.1.1	6	<b>6</b>	.			Name		
								Number		

Mike Hürlimann Pilot  
 MDM-1 HB-3241 A/C

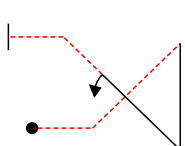
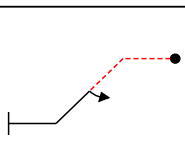
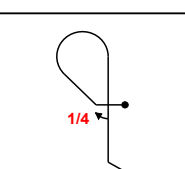
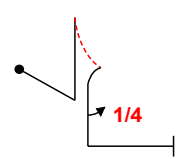
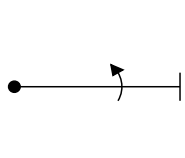
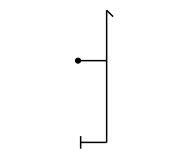
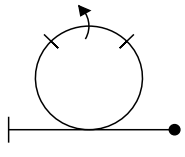
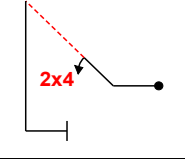
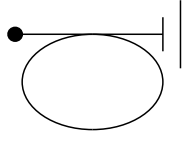

		Form B
Pilot ID	CIVA Glider Advanced Known	
	Flight #	

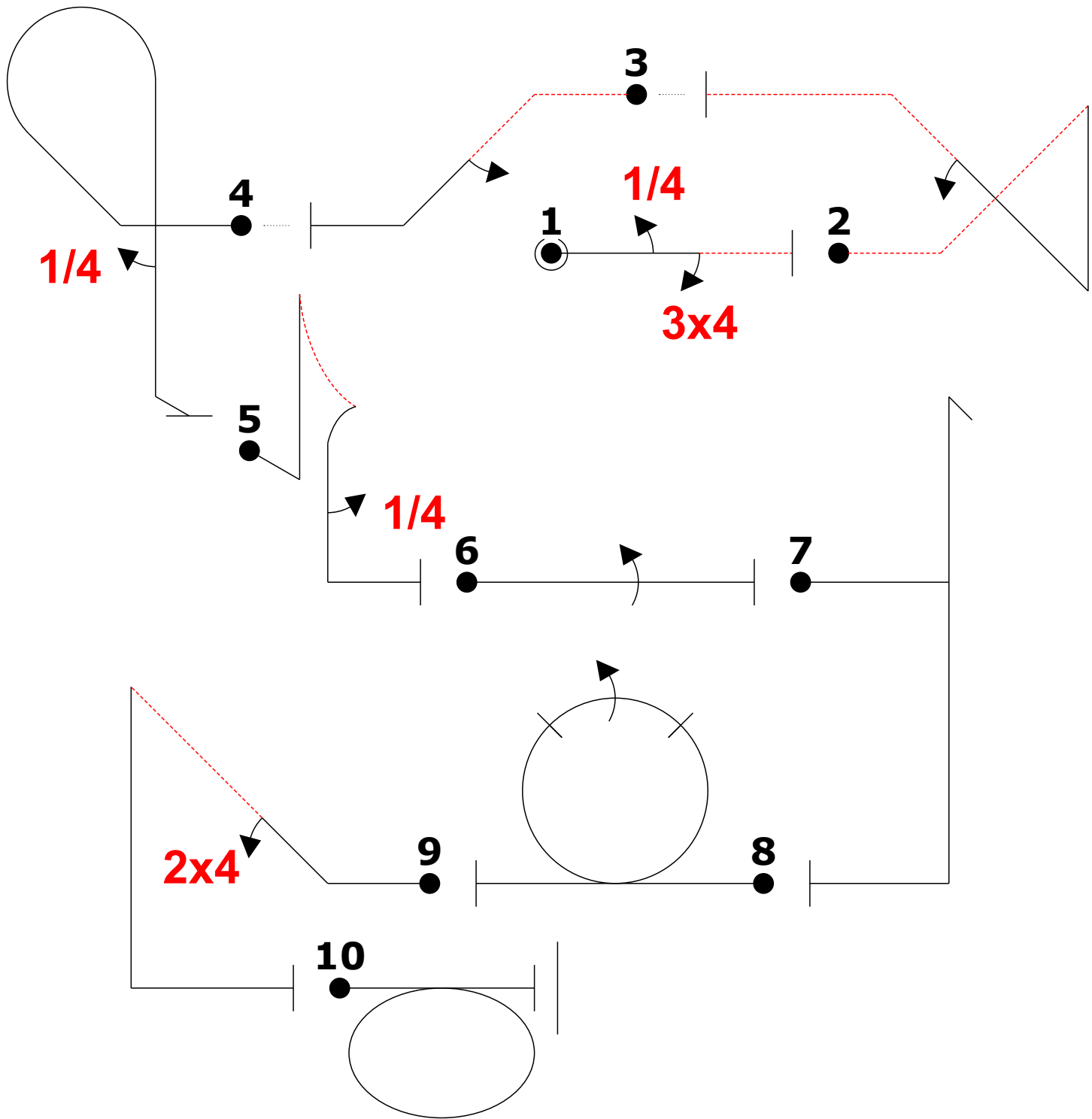
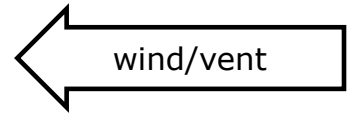

"@B" 4,34- -""w2-- (1,0) -id2 (1,0) "@D" -2% /~~'y.'',4+' "@E" > """"+ita""""4'+""""> .1~ ~h...''~ "@C" o1 "@A" 24.'t.''+ 4j

**Mike Hürlimann** Pilot  
**MDM-1 HB-3241** A/C



		Form C
Pilot ID	CIVA Glider Advanced Known	
		Flight #

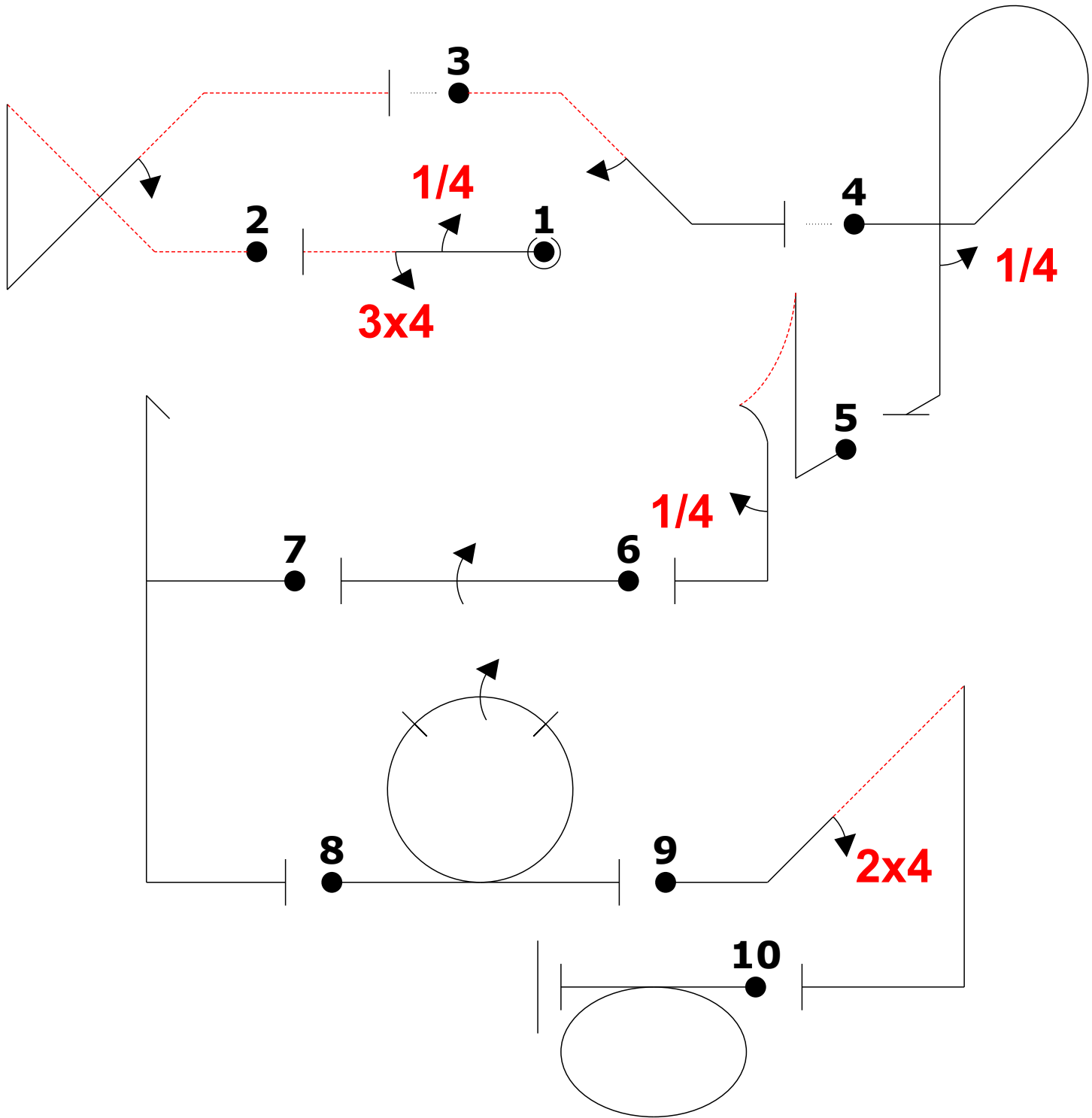
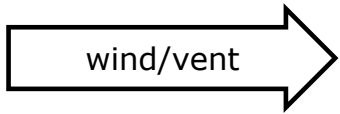

"@B" 4,34- -""w2-- (1,0) -id2 (1,0) "@D" -2% /~~~y.'',4+' "@E" > """"+ita""""4'+""""> .1~ ~h...~~ "@C" o1 "@A" 24.'t.''+ 4j

**Mike Hürlimann** Pilot  
**MDM-1 HB-3241** A/C



CIVA Advanced Glider  
Known

wind/vent ← **R**

Figure K  
**175**  
Total K  
**195**

Judges Name	
Signature	Number

Flight #
----------

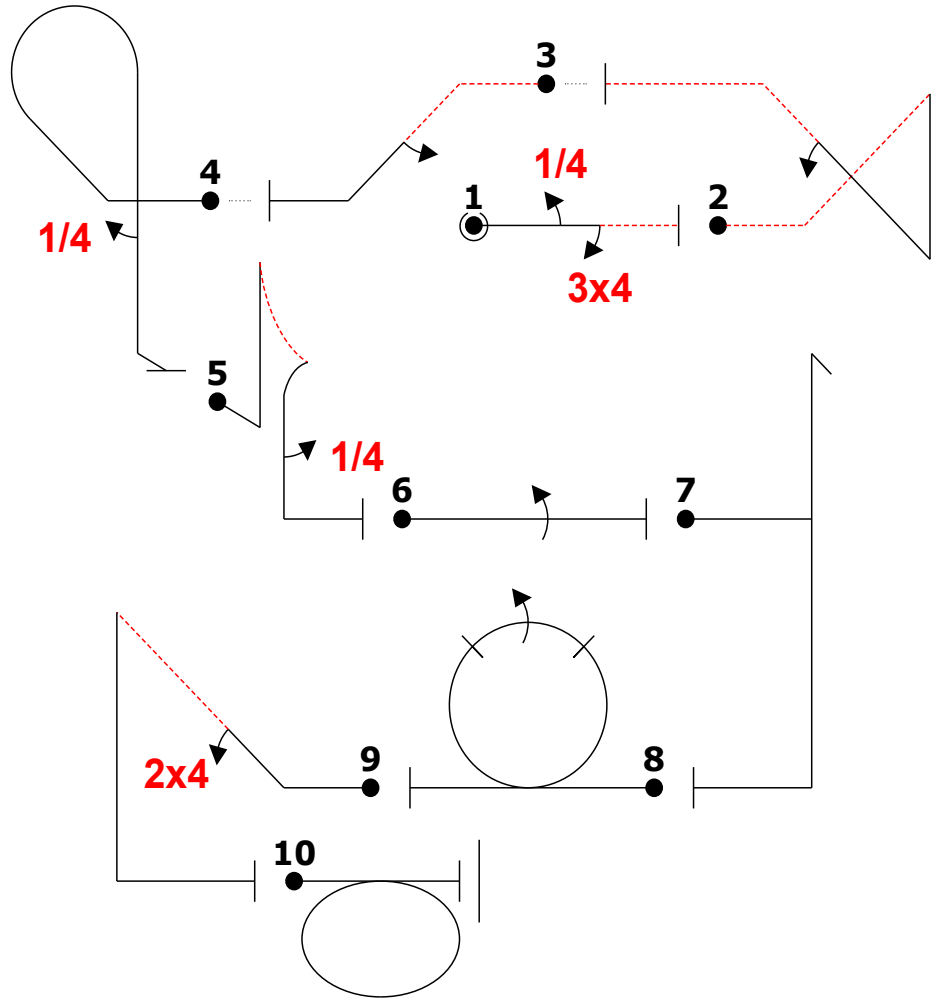

Fig	Grade	Pos	Remarks
1	.		
2	.		
3	.		
4	.		
5	.		
6	.		
7	.		
8	.		
9	.		
10	.		

Positioning **20**

Too Low		Trg Violation	
Too High		Wing Rocks	
Interruptions		Disqual Fig	
Insertions		Other(note...)	

"@B" 4,34- -`w2--- (1,0) -id2 (1,0) "@D" -2% /~\y.';4'+ "E" > ~~~~~+ita~~~~4'+~~~~> .  
1~ ~h..~ "C" o1 "@A" 24.'t.''+ 4j

Fig 1 B	K	Fig 2	K	Fig 3	K	Fig 4 D	K	Fig 5 E	K	Fig 6	K	Fig 7	K	Fig 8 C	K	Fig 9 A	K	Fig 10	K
1.1.1.3	2	1.3.3.2	19	1.1.3.4	7	8.5.9.1	12	6.2.2.1	17	1.1.1.1	2	5.2.1.1	17	7.4.1.1	10	1.2.3.1	12	2.4.1.1	6
9.1.3.1	3	9.1.2.2	9	9.1.4.2	6	9.1.5.1	3	9.1.5.1	3	9.1.3.4	12			9.1.3.4	12	9.4.2.2	11		
9.4.3.3	12																		
	<b>17</b>		<b>28</b>		<b>13</b>		<b>15</b>		<b>20</b>		<b>14</b>		<b>17</b>		<b>22</b>		<b>23</b>		<b>6</b>

Pilot: Mike Hürlimann

A/C: MDM-1 HB-3241

Team: SUI



CIVA Advanced Glider  
Known

Figure K  
**175**  
Total K  
**195**

Judges Name	
Signature	Number

Flight #
----------

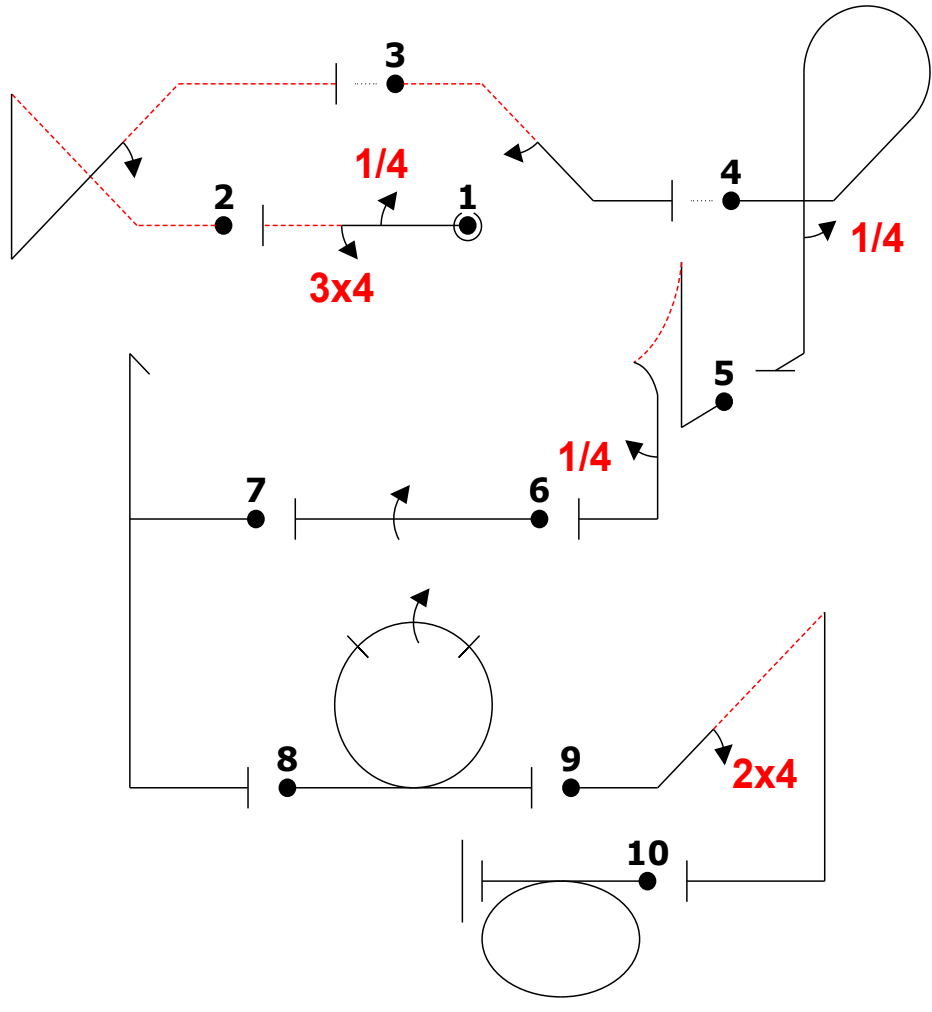
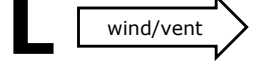

Fig	Grade	Pos	Remarks
1	.		
2	.		
3	.		
4	.		
5	.		
6	.		
7	.		
8	.		
9	.		
10	.		

Positioning **20**

Too Low		Trg Violation	
Too High		Wing Rocks	
Interruptions		Disqual Fig	
Insertions		Other(note...)	

"@B" 4,34- -`w2--- (1,0) -id2 (1,0) "@D" -2% /~\y.';4'+ "E" > ~~~~~+ita~~~~4'+~~~~> .  
1~ ~h...~ "C" o1 "@A" 24.'t.''+ 4j

Fig 1 B	K	Fig 2	K	Fig 3	K	Fig 4 D	K	Fig 5 E	K	Fig 6	K	Fig 7	K	Fig 8 C	K	Fig 9 A	K	Fig 10	K
1.1.1.3	2	1.3.3.2	19	1.1.3.4	7	8.5.9.1	12	6.2.2.1	17	1.1.1.1	2	5.2.1.1	17	7.4.1.1	10	1.2.3.1	12	2.4.1.1	6
9.1.3.1	3	9.1.2.2	9	9.1.4.2	6	9.1.5.1	3	9.1.5.1	3	9.1.3.4	12			9.1.3.4	12	9.4.2.2	11		
9.4.3.3	12																		
	<b>17</b>		<b>28</b>		<b>13</b>		<b>15</b>		<b>20</b>		<b>14</b>		<b>17</b>		<b>22</b>		<b>23</b>		<b>6</b>

Pilot: Mike Hürlimann

A/C: MDM-1 HB-3241

Team: SUI

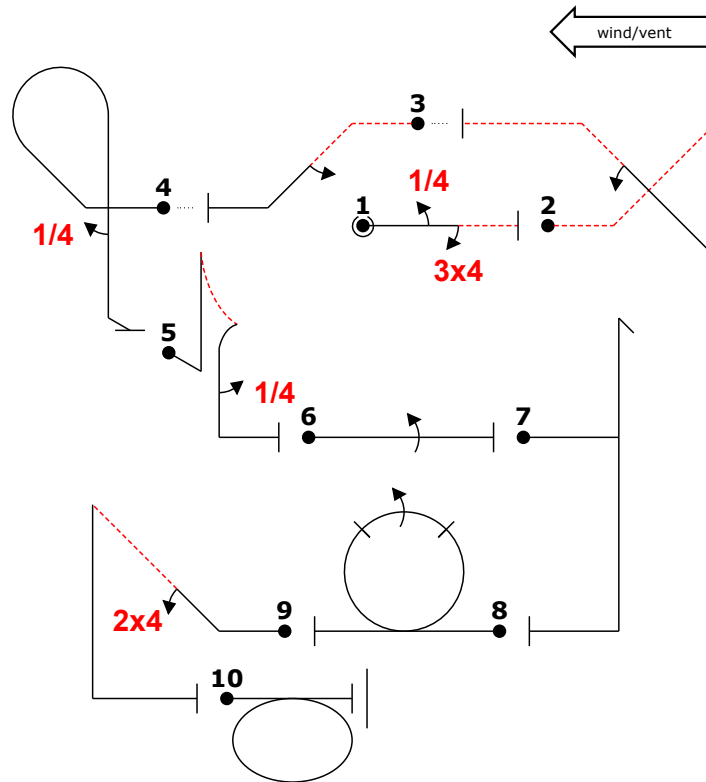
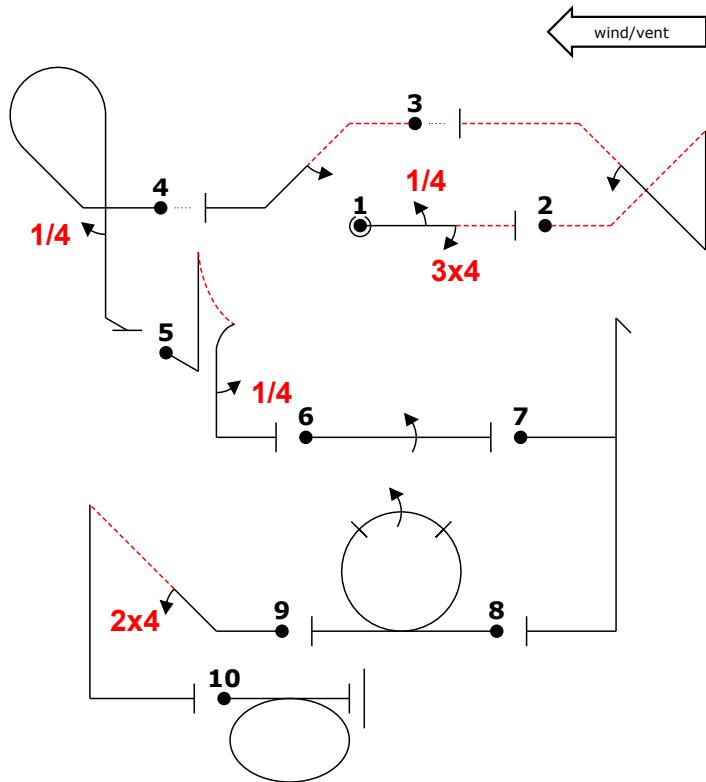
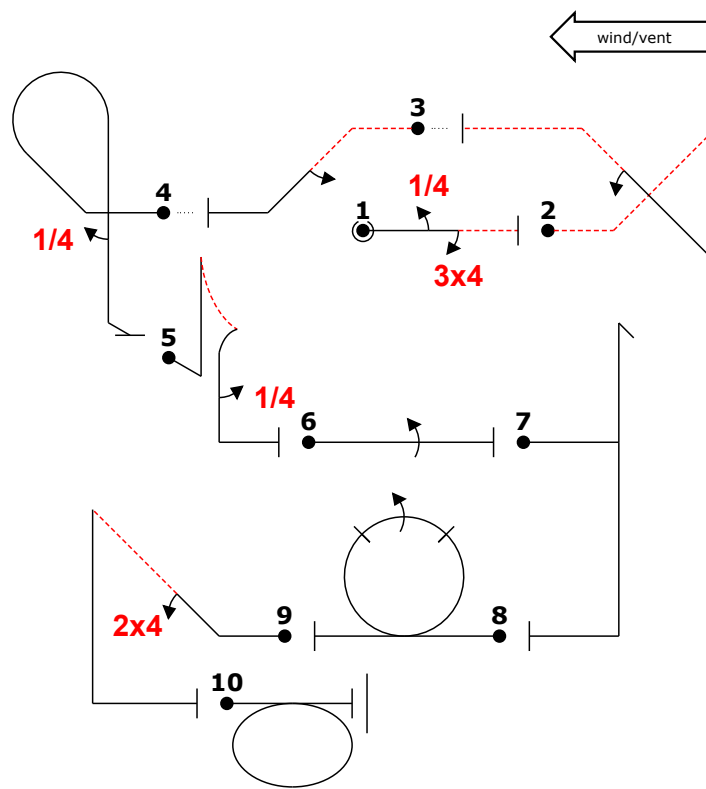
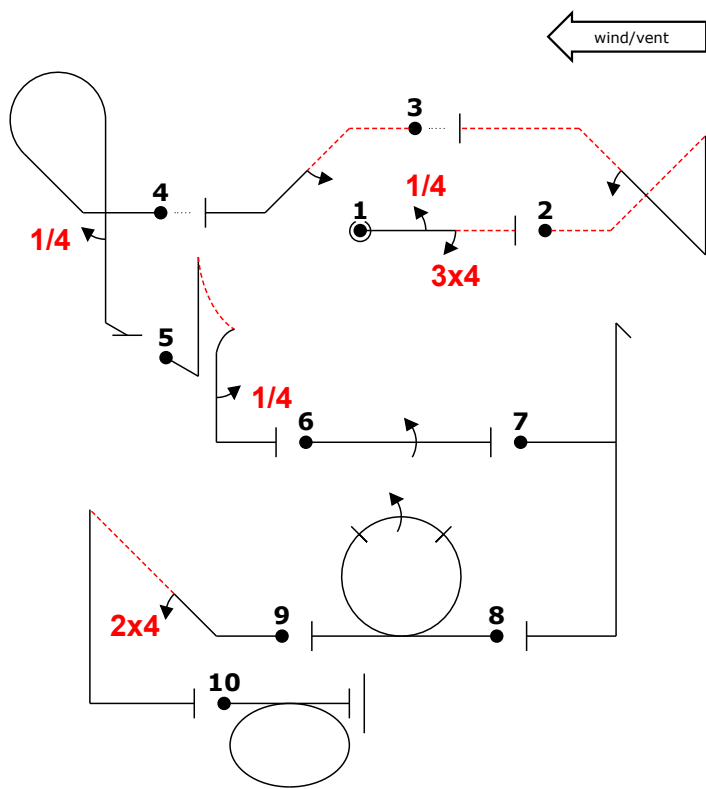

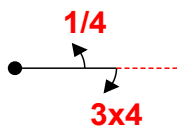
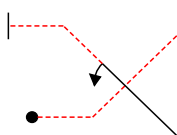
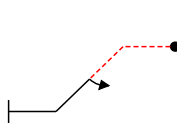
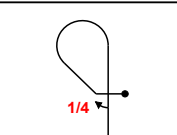
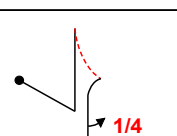
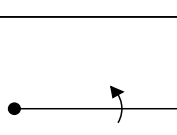
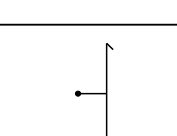
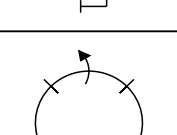
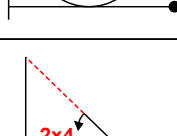
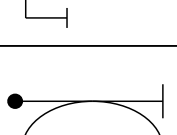

<b>Form A</b>	
Pilot ID	<b>CIVA Glider Advanced Known</b>
Flight #	

No	Symbol	Cat. No.	K	Total K	Grade	Pos	Remarks	Item	K	Grade
<b>1</b>		1.1.1.3 9.1.3.1 9.4.3.3	2 3 12	<b>17</b>	.			Pos.	20	
								Harm.	0	
<b>2</b>		1.3.3.2 9.1.2.2	19 9	<b>28</b>	.			Fig K		Total K
								175	195	
<b>3</b>		1.1.3.4 9.1.4.2	7 6	<b>13</b>	.			<b>Penalties</b>		
								Too Low		
<b>4</b>		8.5.9.1 9.1.5.1	12 3	<b>15</b>	.			Too High		
								Interruptions		
<b>5</b>		6.2.2.1 9.1.5.1	17 3	<b>20</b>	.			Insertions		
								Trg Violation		
<b>6</b>		1.1.1.1 9.1.3.4	2 12	<b>14</b>	.			Wing Rocks		
								Disqual Fig		
<b>7</b>		5.2.1.1	17	<b>17</b>	.			Other(note...)		
								<b>Final Freestyle</b>		
<b>8</b>		7.4.1.1 9.1.3.4	10 12	<b>22</b>	.			Duration	Min	Sec
<b>9</b>		1.2.3.1 9.4.2.2	12 11	<b>23</b>	.			<b>Judges Details</b>		
								Signature		
<b>10</b>		2.4.1.1	6	<b>6</b>	.			Name		
								Number		

**Christian Syfrig** Pilot  
**MDM-1 HB-3241** A/C



		Form B
Pilot ID	CIVA Glider Advanced Known	
		Flight #

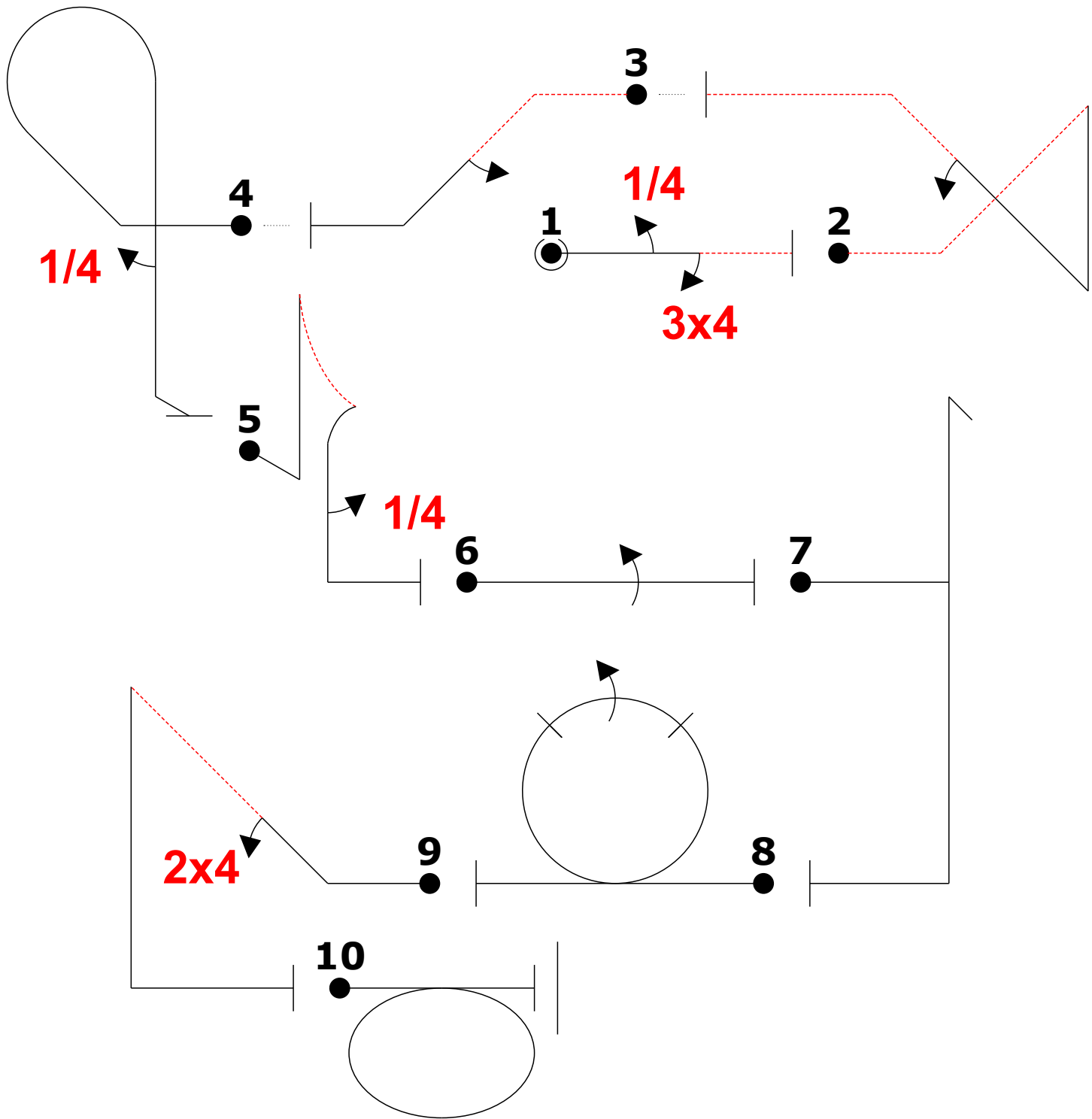
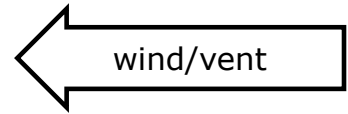

"@B" 4,34- -""w2-- (1,0) -id2 (1,0) "@D" -2% /~~~y.' ,4+' "@E" > ~~~~~+ita~~~~4'+~~~~> .1~ ~h...~~ "@C" o1 "@A" 24.'t.''+ 4j

Christian Syfrig Pilot  
MDM-1 HB-3241 A/C





		Form C
Pilot ID	CIVA Glider Advanced Known	
		Flight #

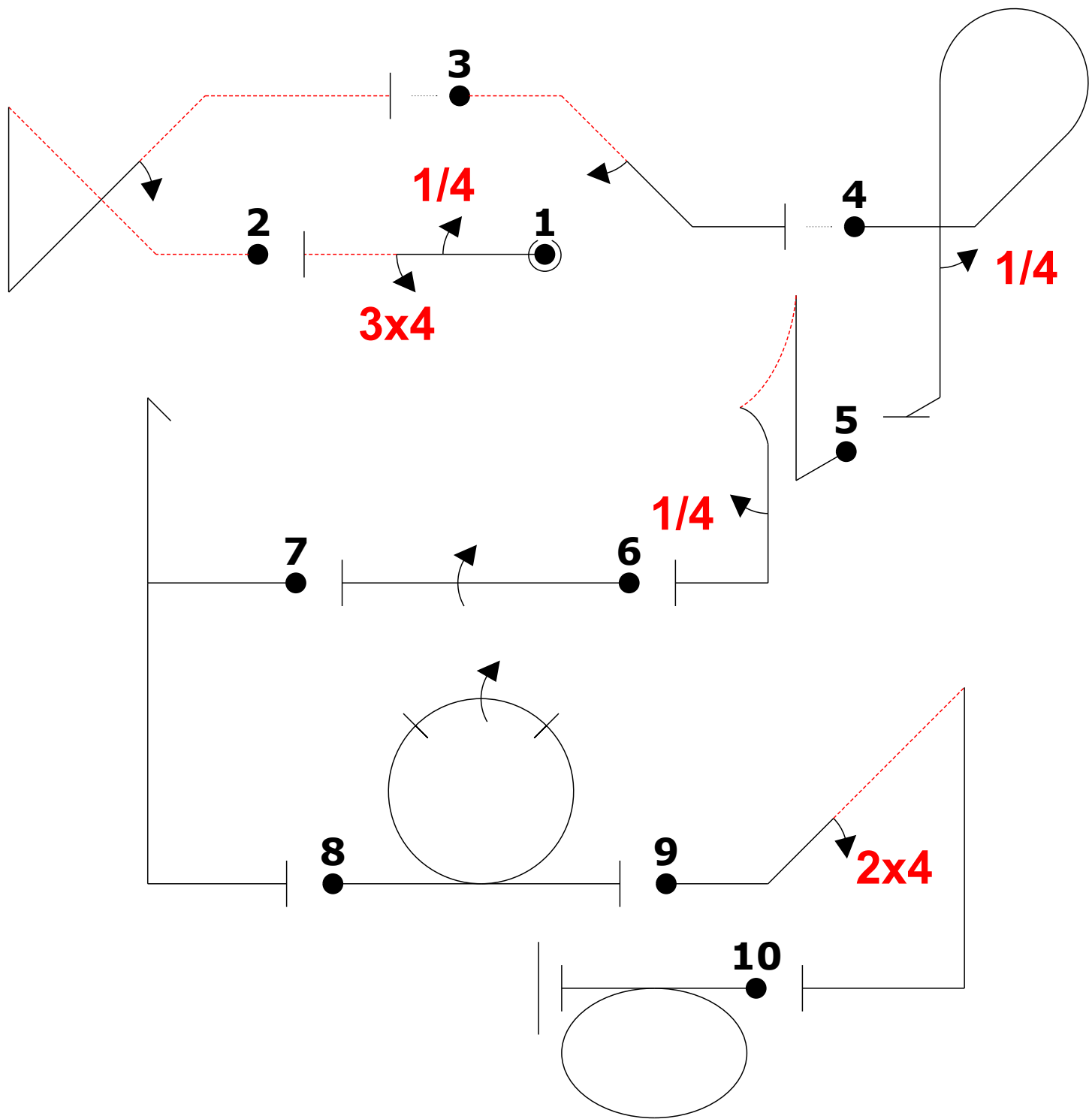
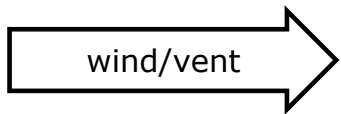

"@B" 4,34- -""w2-- (1,0) -id2 (1,0) "@D" -2% /~~'y.'',4'+ ' "@E" > """"+ita""""4'+""""> .1~ ~h..."" "@C" o1 "@A" 24.'t.''+ 4j

**Christian Syfrig** Pilot  
**MDM-1 HB-3241** A/C



CIVA Advanced Glider  
Known

wind/vent ← **R**

Figure K  
175  
Total K  
195

Judges Name	
Signature	Number

Flight #
----------

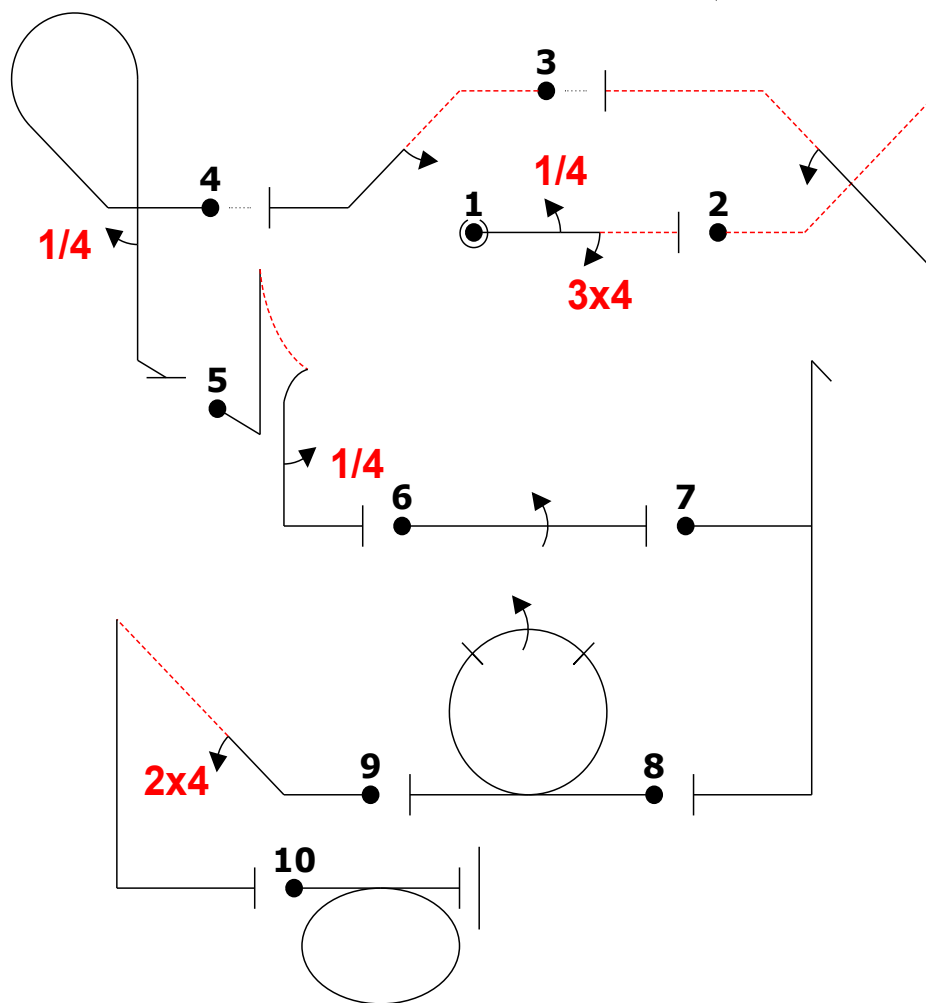

Fig	Grade	Pos	Remarks
1	.		
2	.		
3	.		
4	.		
5	.		
6	.		
7	.		
8	.		
9	.		
10	.		

Positioning **20**

Too Low		Trg Violation	
Too High		Wing Rocks	
Interruptions		Disqual Fig	
Insertions		Other(note...)	

"@B" 4,34- -`w2--- (1,0) -id2 (1,0) "@D" -2% /~\y.';4'+ "E" > ~~~~~+ita~~~~4'+~~~~> .  
1~ ~h..~ "C" o1 "@A" 24.'t.''+ 4j

Fig 1 B	K	Fig 2	K	Fig 3	K	Fig 4 D	K	Fig 5 E	K	Fig 6	K	Fig 7	K	Fig 8 C	K	Fig 9 A	K	Fig 10	K
1.1.1.3	2	1.3.3.2	19	1.1.3.4	7	8.5.9.1	12	6.2.2.1	17	1.1.1.1	2	5.2.1.1	17	7.4.1.1	10	1.2.3.1	12	2.4.1.1	6
9.1.3.1	3	9.1.2.2	9	9.1.4.2	6	9.1.5.1	3	9.1.5.1	3	9.1.3.4	12			9.1.3.4	12	9.4.2.2	11		
9.4.3.3	12																		
	<b>17</b>		<b>28</b>		<b>13</b>		<b>15</b>		<b>20</b>		<b>14</b>		<b>17</b>		<b>22</b>		<b>23</b>		<b>6</b>

Pilot: Christian Syfrig

A/C: MDM-1 HB-3241

Team: SUI



CIVA Advanced Glider

Known

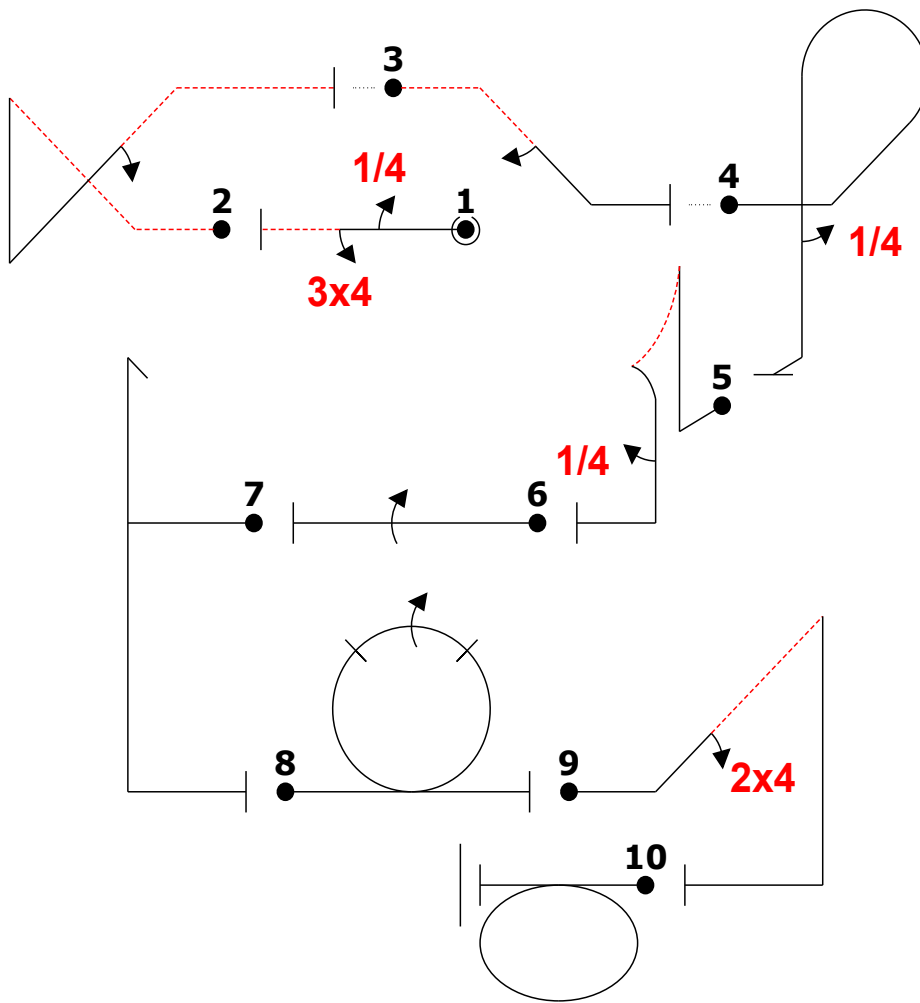
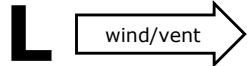

Figure K  
175  
Total K  
195

Judges Name		Flight #
Signature	Number	

Fig	Grade	Pos	Remarks
1	.		
2	.		
3	.		
4	.		
5	.		
6	.		
7	.		
8	.		
9	.		
10	.		

Positioning  
20 .

Too Low		Trg Violation	
Too High		Wing Rocks	
Interruptions		Disqual Fig	
Insertions		Other(note...)	

"@B" 4,34- -`w2-~ (1,0) -id2 (1,0) "@D" -2% /~\y.';4'+ "E" > ~~~~~+ita~~~~4'+~~~~> .  
1~ ~h...~ "C" o1 "@A" 24.'t.''+ 4j

Fig 1 B	K	Fig 2	K	Fig 3	K	Fig 4 D	K	Fig 5 E	K	Fig 6	K	Fig 7	K	Fig 8 C	K	Fig 9 A	K	Fig 10	K
1.1.1.3	2	1.3.3.2	19	1.1.3.4	7	8.5.9.1	12	6.2.2.1	17	1.1.1.1	2	5.2.1.1	17	7.4.1.1	10	1.2.3.1	12	2.4.1.1	6
9.1.3.1	3	9.1.2.2	9	9.1.4.2	6	9.1.5.1	3	9.1.5.1	3	9.1.3.4	12			9.1.3.4	12	9.4.2.2	11		
9.4.3.3	12																		
	<b>17</b>		<b>28</b>		<b>13</b>		<b>15</b>		<b>20</b>		<b>14</b>		<b>17</b>		<b>22</b>		<b>23</b>		<b>6</b>

Pilot: Christian Syfrig

A/C: MDM-1 HB-3241

Team: SUI

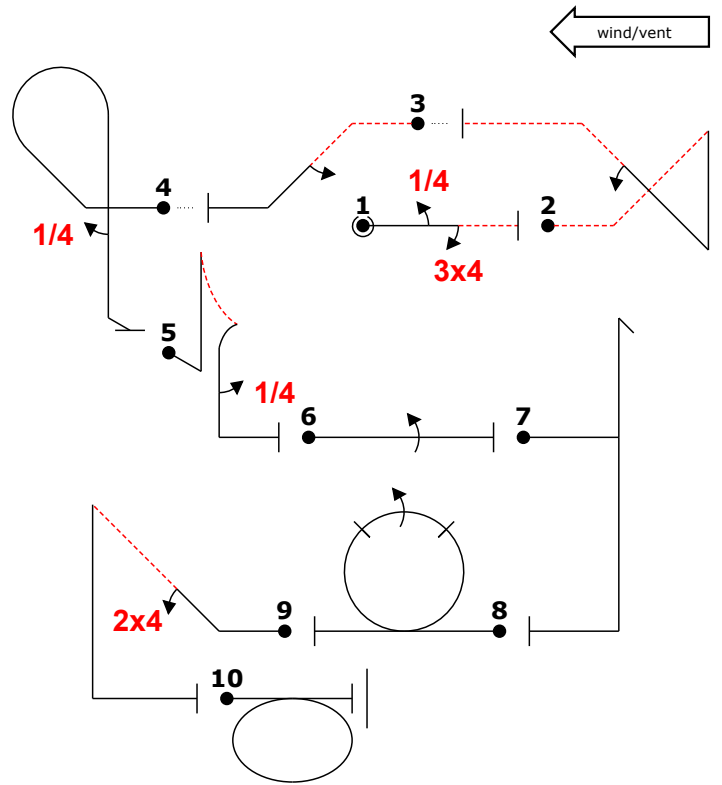
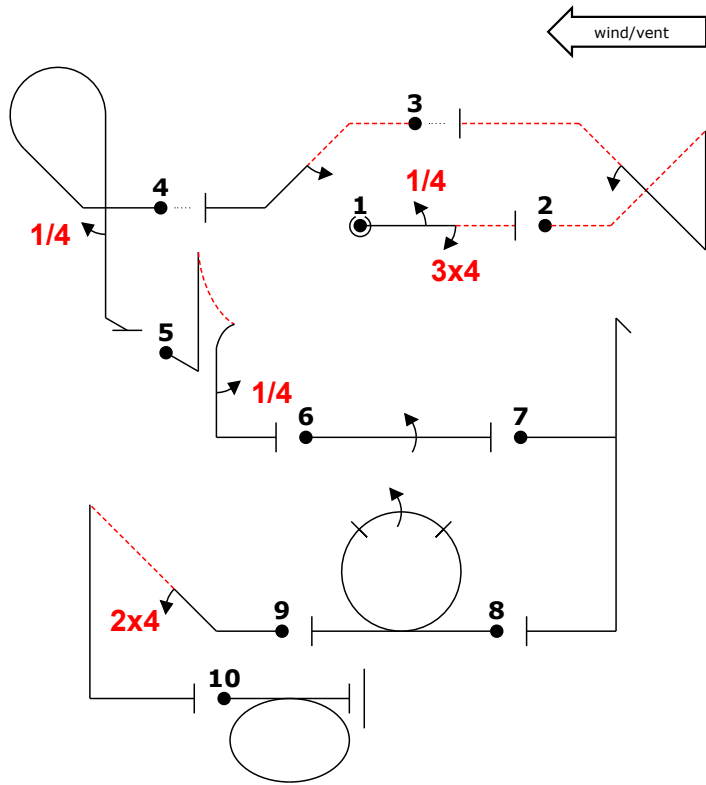
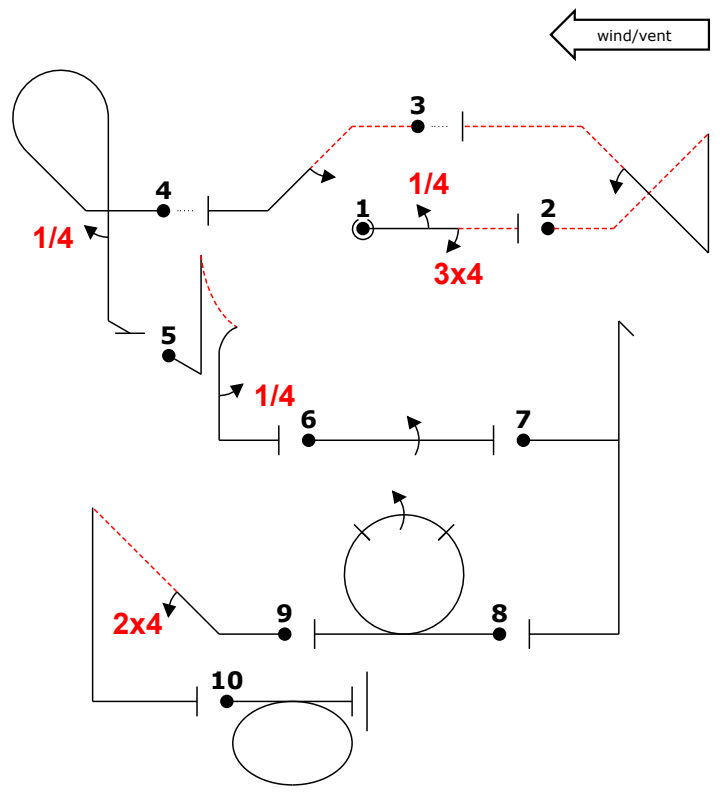
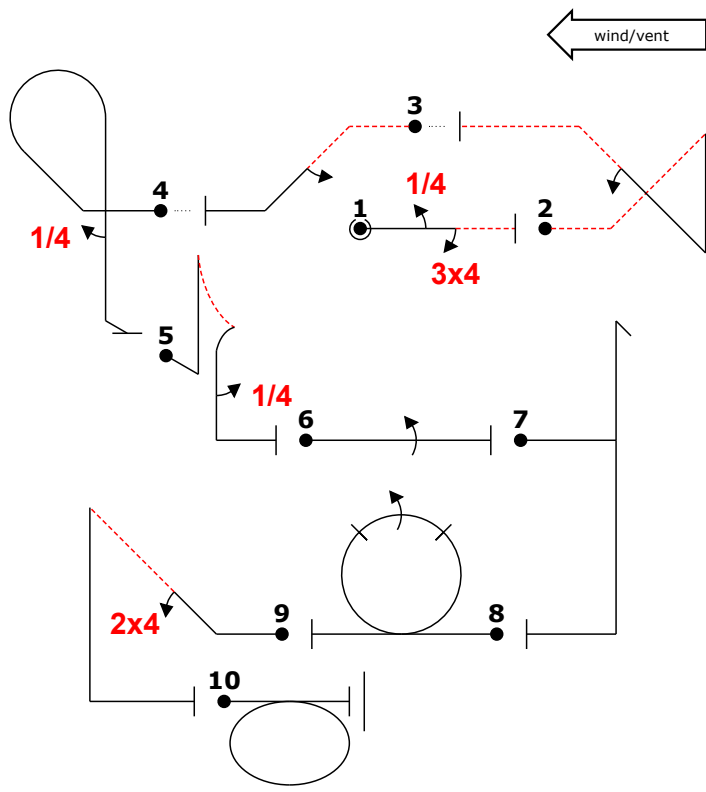

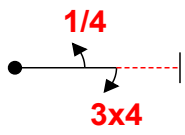
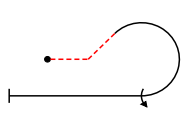
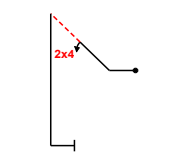
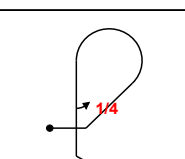
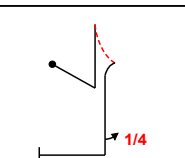
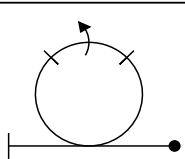
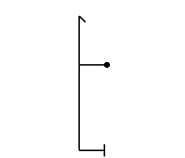
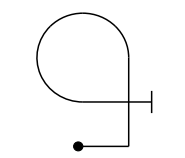
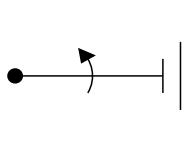

Pilot ID		Flight #
<b>CIVA Glider Advanced Known</b>		
Form A		

No	Symbol	Cat. No.	K	Total K	Grade	Pos	Remarks	Item	K	Grade
<b>1</b>		1.1.1.3 9.1.3.1 9.4.3.3	2 3 12	<b>Fig B</b> <b>17</b>	.			Pos.	20	
								Harm.	0	
<b>2</b>		8.5.1.2 9.1.3.4	10 12	<b>21</b> (22)	.			Fig K	Total K	
								175	195	
<b>3</b>		1.2.3.1 9.4.2.2	12 11	<b>Fig A</b> <b>23</b>	.			<b>Penalties</b>		
								Too Low		
								Too High		
								Interruptions		
								Insertions		
								Trg Violation		
								Wing Rocks		
								Disqual Fig		
Other(note...)										
<b>5</b>		8.5.9.1 9.1.5.1	12 3	<b>Fig D</b> <b>15</b>	.			<b>Final Freestyle</b>		
								Duration	Min	Sec
<b>6</b>		6.2.2.1 9.1.5.1	17 3	<b>Fig E</b> <b>20</b>	.			<b>Judges Details</b>		
								Signature		
<b>7</b>		7.4.1.1 9.1.3.4	10 12	<b>Fig C</b> <b>22</b>	.			Name		
								Number		
<b>8</b>		5.2.1.1	17	<b>17</b>	.					
<b>9</b>		8.6.1.1	11	<b>11</b>	.					
<b>10</b>		1.1.1.1 9.1.3.4	2 12	<b>14</b>	.					

**Pascal Zollikofer** Pilot  
**SZD-59 HB-3559** A/C



		Form B
Pilot ID	CIVA Glider Advanced Known	
	Flight #	

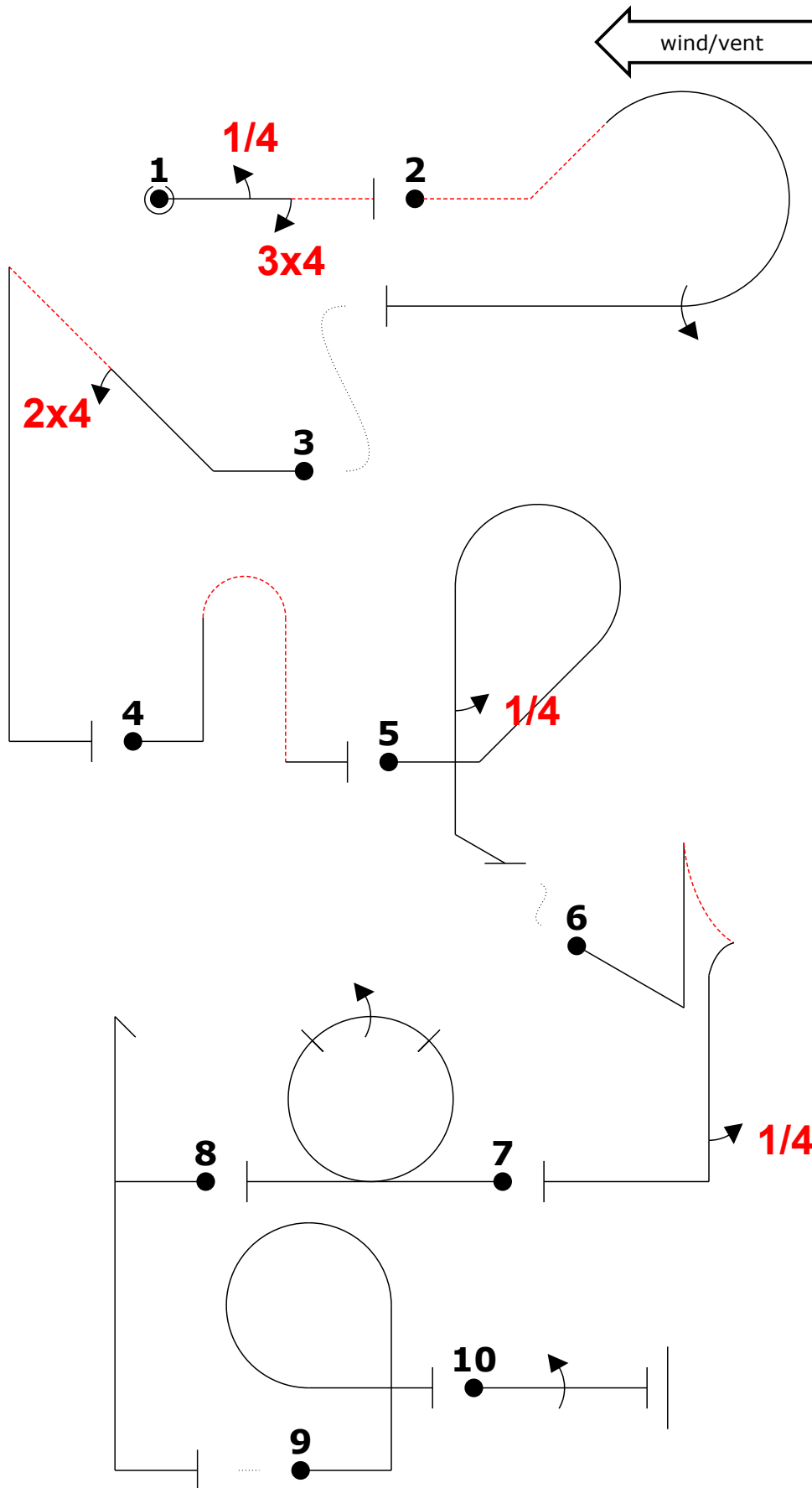

"@B" 4,34- 3% .....rc1+"" "@A" (0,8) .24.t..... ""+`pb""+"" "@D" /y4 "@E" (0,2) ita4> "@C" ol h...' (1,0) rp 1

Pascal Zollikofer  
Pilot  
SZD-59 HB-3559  
A/C



		Form C
Pilot ID	CIVA Glider Advanced Known	
	Flight #	

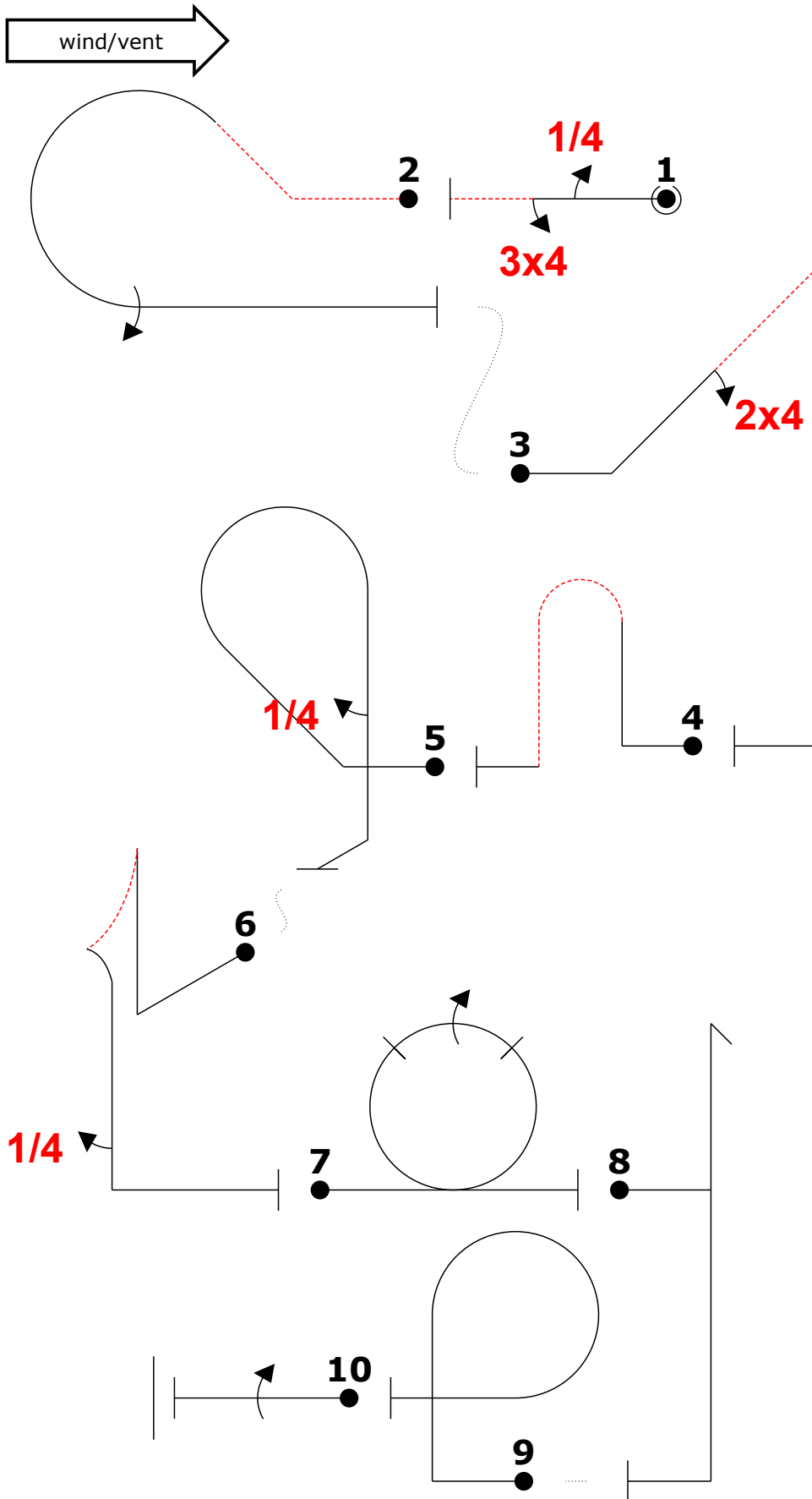

"@B" 4,34- 3% ~~~~~rc1+"" "@A" (0,8) .24.t..... ""+`pb""+"" "@D" /y4 "@E" (0,2) ita4> "@C" ol h...'' (1,0) rp 1

Pascal Zollikofer  
Pilot  
SZD-59 HB-3559  
A/C



CIVA Advanced Glider  
Known

Figure K  
175  
Total K  
195

Judges Name	
Signature	Number

Flight #

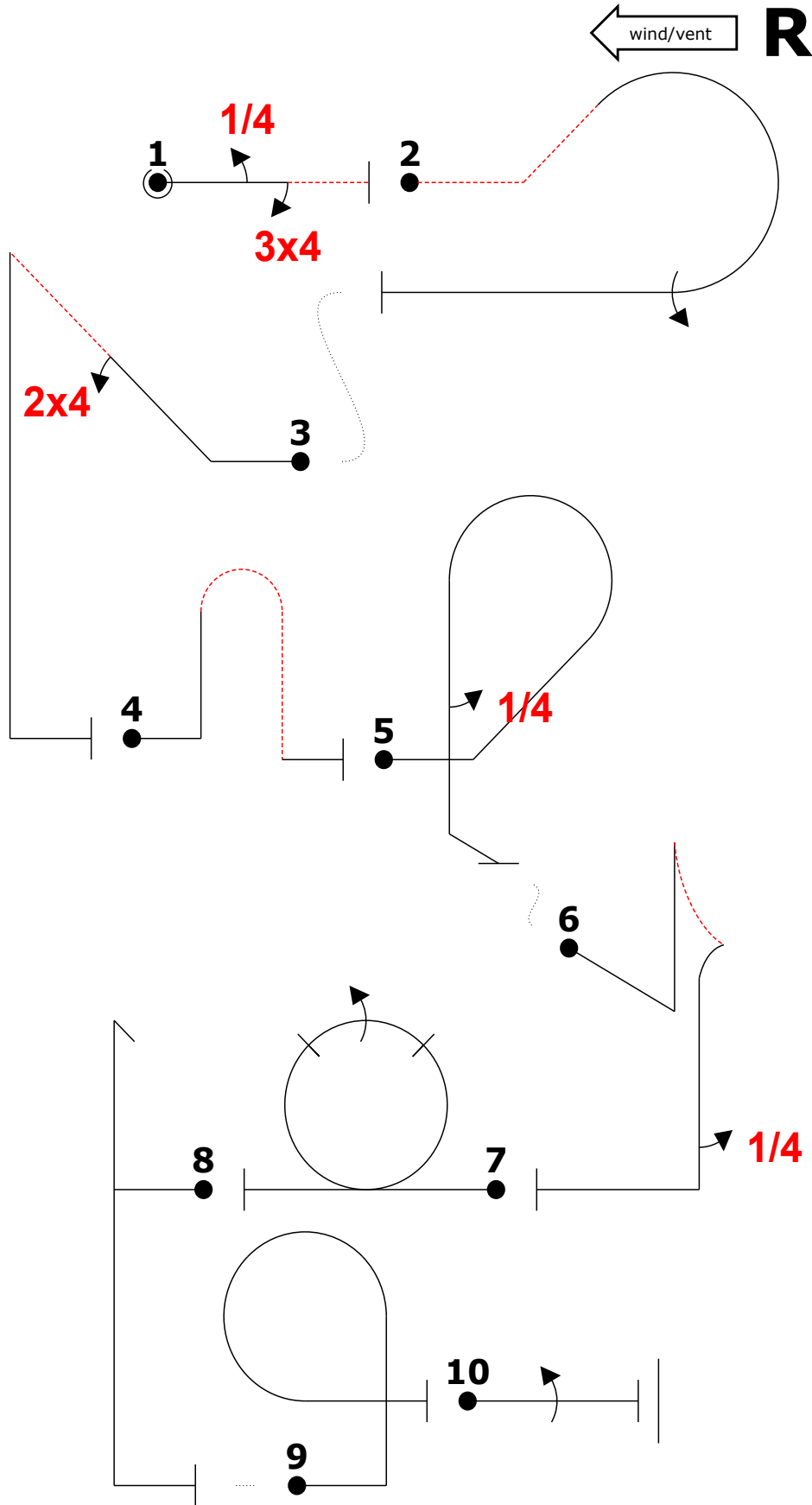

Fig	Grade	Pos	Remarks
1	.		
2	.		
3	.		
4	.		
5	.		
6	.		
7	.		
8	.		
9	.		
10	.		

Positioning  
20

Too Low		Trg Violation	
Too High		Wing Rocks	
Interruptions		Disqual Fig	
Insertions		Other(note...)	

"@B" 4,34- 3% -"rc1+" "A" (0,8) .24.t..... "+"pb"" "D" / y4 "E" (0,2) ita4> "C" oi h..." (1,0) rp 1

Fig 1 B	K	Fig 2	K	Fig 3 A	K	Fig 4	K	Fig 5 D	K	Fig 6 E	K	Fig 7 C	K	Fig 8	K	Fig 9	K	Fig 10	K
1.1.1.3	2	8.5.1.2	10	1.2.3.1	12	8.4.3.1	15	8.5.9.1	12	6.2.2.1	17	7.4.1.1	10	5.2.1.1	17	8.6.1.1	11	1.1.1.1	2
9.1.3.1	3	9.1.3.4	12	9.4.2.2	11			9.1.5.1	3	9.1.5.1	3	9.1.3.4	12					9.1.3.4	12
9.4.3.3	12																		
	17	(-1)21		23		15		15		20		22		17		11		14	

Pilot: Pascal Zollikofer

A/C: SZD-59 HB-3559

Team: SUI





CIVA Advanced Glider  
Known

Figure K  
**175**  
Total K  
**195**

Judges Name	
Signature	Number

Flight #
----------

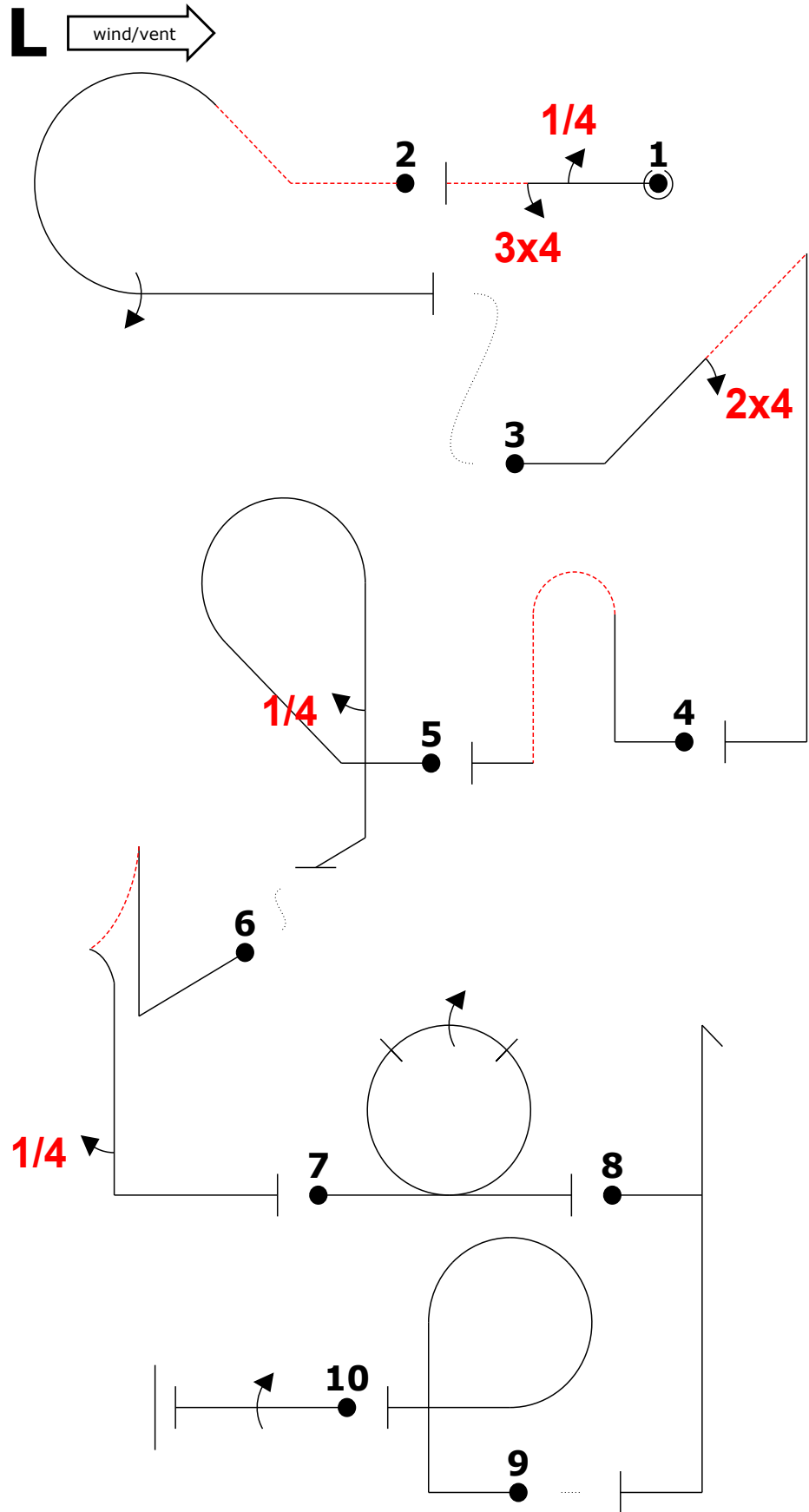

Fig	Grade	Pos	Remarks
1	.		
2	.		
3	.		
4	.		
5	.		
6	.		
7	.		
8	.		
9	.		
10	.		

Positioning **20**

Too Low		Trg Violation	
Too High		Wing Rocks	
Interruptions		Disqual Fig	
Insertions		Other(note...)	

"@B" 4,34- 3% - "rc1+" "A" (0,8) .24.t..... "pb" "D" / y4 "E" (0,2) ita4> "C" oi h... (1,0) rp 1

Fig 1 B	K	Fig 2	K	Fig 3 A	K	Fig 4	K	Fig 5 D	K	Fig 6 E	K	Fig 7 C	K	Fig 8	K	Fig 9	K	Fig 10	K
1.1.1.3	2	8.5.1.2	10	1.2.3.1	12	8.4.3.1	15	8.5.9.1	12	6.2.2.1	17	7.4.1.1	10	5.2.1.1	17	8.6.1.1	11	1.1.1.1	2
9.1.3.1	3	9.1.3.4	12	9.4.2.2	11			9.1.5.1	3	9.1.5.1	3	9.1.3.4	12					9.1.3.4	12
9.4.3.3	12																		
	<b>17</b>		<b>(-1)21</b>		<b>23</b>		<b>15</b>		<b>15</b>		<b>20</b>		<b>22</b>		<b>17</b>		<b>11</b>		<b>14</b>

Pilot: Pascal Zollikofer

A/C: SZD-59 HB-3559

Team: SUI

